

Domino Pig Sort – an example of a large common pen

In this example we have chosen to arrange the large pen as a Multi-function-stable where it is also used as delivery area.





As it appears from the drawing there is a feeding area with relief pens, this area is placed in the pen so that there is a passage of 2-3 meters around it. The feeding area is placed in that part of the stable where the exit/door to the delivery of the pigs is placed.

There are doors at the sides of the feeding area. Normally these doors will be open in order that the pigs can use the whole area. When time has come for delivery of pigs, a sorting will take place, and then the doors corresponding to the room needed for the number of pigs to be sorted out, will be closed.

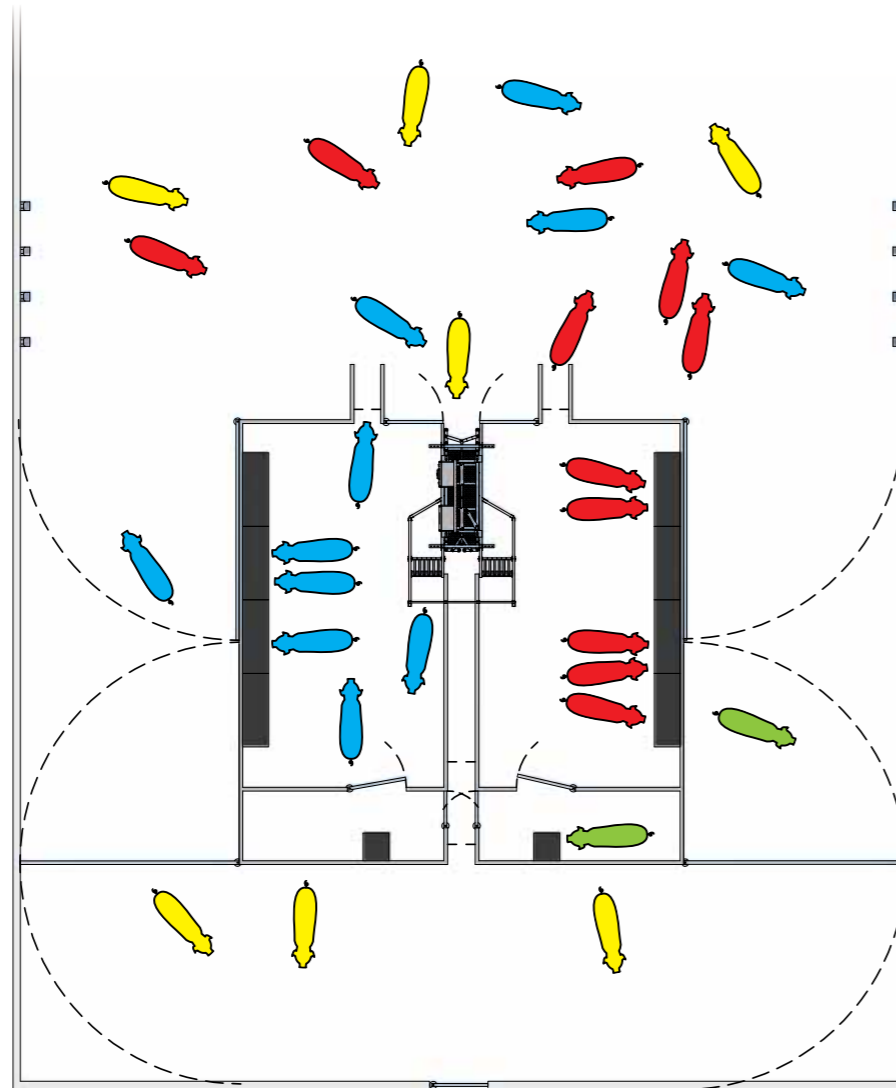
The doors will be closed in a way leaving a closed area round the sorting exit in the middle. This is to take place just before the sorting is started. The time for the sorting is controlled by the computer, it takes approx. 12-16 hours. When the pigs that have been sorted out have been picked up the doors can be opened again and the remaining pigs can use the whole area.

To ensure a large feed intake in a short time it is recommended to use ad-lib feeders featuring head separation and water supply which ensures calm pigs and minimum feed waste. The ad-lib feeders should be placed by the walls to provide more space in the feeding area. The pigs will quickly spot the free feeding



-  = 50% smallest pigs
-  = 50% largest pigs
-  = Ready to be picked up
-  = Colour marked pigs to relief pen

places and queues by the feeders are avoided. Domino Pig Sort is as well suited for installation in most existing pens as for installation in newly built pens. We understand the importance of correct design, optimal exploitation of the area and the functions. Please contact us if you need further information. Domino recommends 400-450 pigs per scale.

DOMINO Pig Sort

A sorting scale featuring three exits for porkers

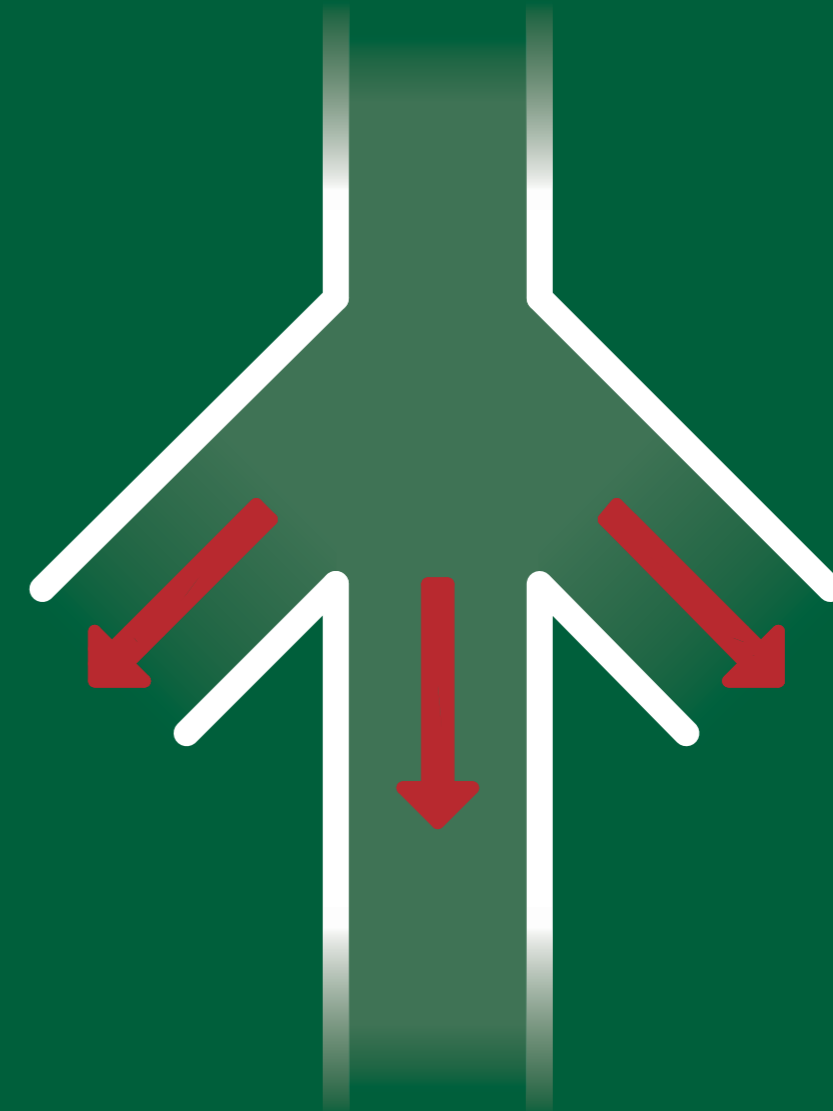

DOMINO Pig Sort sorting scale gives you complete control of pigs in large common pens. Pig Sort allows delivery of pigs based on correct weight and ensures optimal feeding. Pig Sort dramatically reduces labour and makes pig production more efficient, thus leaving more time for management.

A large common pen with DOMINO Pig Sort has the following advantages:

- Delivery at optimal slaughter weight – thus ensuring the farmer the best price.
- Weighing of all pigs quickly, easily and accurately.
- Separate sorting of pigs ready for slaughter through the third exit – preventing that such pigs take up space in the feeding area.
- A complete survey of the current gain.
- Sorting to the two feeding areas allows phase feeding.
- A complete survey of the weight distribution.
- Improved pen utilisation – no walking area.
- No problems associated with mixing of pigs in relief pens and delivery, as they know each other from the large common pen.
- Quick pen washing – less equipment.
- Calm animals – the pigs decide for themselves where in the pen they want to be; large freedom of movement.

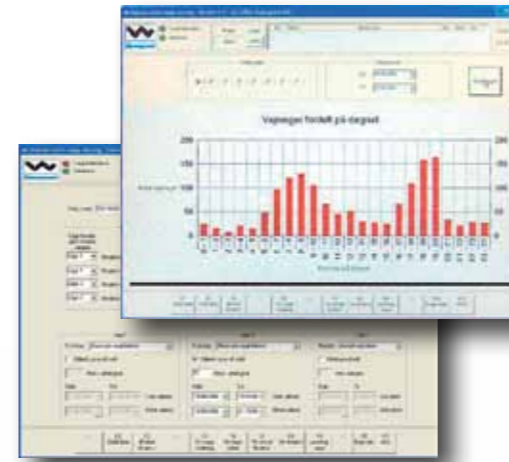
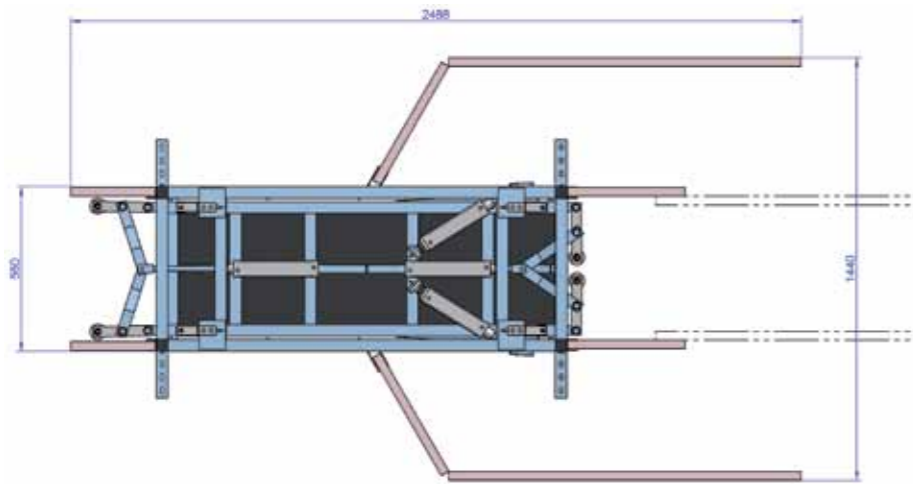

Pig Sort data shows among others:

- Current gain.
- Gain achieved compared with gain expected.
- Weight distribution.
- Number of pigs for delivery next week/weeks.
- Current number of pigs in pen.
- Comparison of data between the various pens, houses and farms.

Pig Sort:

- Pig Sort takes up a minimum of space as doors are integrated in the scale.
- The location of the four load cells at the scale's top ensures quick, reliable and accurate weighing, just as dirt on the floor will not affect the cells.
- Weight division with 100 gram intervals.
- Fully PC-controlled.
- Scale made of stainless steel and PE-plastic.

Pig Sort features:

- Automatically selects pigs with optimal slaughter weight.
- Sorts pigs according to weight or percentage as requested (programmed).
- Displays weight distribution of animals per pen, house, farm and in total.
- Sorts marked pigs to relief pens.
- Features colour marking – of all pigs or according to specific weight group.

